

## 高分子材料への電荷注入過程とその評価 II

高分子材料の電界発光

小 嶋 憲 三

### Carrier Injection Processes into Polymers and Their Evaluations II

Electroluminescence in Polymers

Kenzo KOJIMA

1. Electroluminescence was observed in PET when an impulse voltage was applied. The electroluminescence depended on the electrode material of the cathode and showed only a weak temperature dependence and a superlinear dependence on the electric field. The spectrum of the electroluminescence was identical with that of the photoluminescence originating from PET molecules. Considering these results, the following mechanism was concluded to be responsible for the electroluminescence in PET. Electrons injected from the cathode by tunneling through the interfacial barrier are accelerated by the electric field to sufficiently high energy to excite or ionize PET molecules. They finally lose their energy and become trapped, forming a space charge layer. The electroluminescence occurs when the excited PET molecules are deactivated into their ground states.

The generation and dissipation of the space charge is discussed in this paper, and analysis of the electroluminescence is shown to be useful for understanding the dynamic behavior of the space charge in polymers.

2. Electroluminescence in PET was also observed under AC voltages. The electroluminescence was found to be controlled by the injection of electrons from the Al electrode, together with the space charge accumulation. The occurrence of the injection and accumulation of electrons was demonstrated by thermally stimulated current analysis. The significant modification of the internal field by the space charge resulted in an asymmetrical waveform of the electroluminescence in each half-cycle of the AC voltage.

#### Introduction

In general, it is difficult to apply the simple band theory to polymeric materials because they are amorphous or semicrystalline. Intramolecularly, however, it has been clarified theoretically and experimentally to form the band structure through covalent bonds.<sup>1)</sup> We can actually understand many of electric phenomena in polymers, such as electronic conduction, photoconduction, luminescence and electrical breakdown, according to the band model. The electrical breakdown in low temperature region has been understood to occur in electronic processes, which may be concerned closely with the high field electrical conduction. On the other hand, the electrical transport was restricted strongly by the carrier traps in polymers. Therefore, it is important to understand the carrier generation, transport and trapping phenomena.

In the present paper, the electronic properties of

aromatic polyesters, such as the carrier injection and trapping phenomena, were investigated by the electroluminescence and thermally stimulated current techniques.

Electroluminescence (EL) in polymers has been investigated by several workers, using AC<sup>2,3)</sup> or impulse voltages.<sup>3,4)</sup> Several mechanisms have been considered as explanations of the EL in polymers. Generally, emission occurs in two ways. One is emission resulting from the recombination of an electron and a hole injected from the electrode or ejected from localized states and then accelerated by high electric fields. The secondary factor seriously affecting the EL is space charge accumulation, which modifies the field intensity in the bulk or in the surface layer of polymers.

The accumulation of space charges has been found in the study of treeing breakdown phenomena.<sup>5,6)</sup> Treeing breakdown channels were observed on applying an impulse voltage to a specimen to which a

DC voltage of opposite polarity to the impulse voltage had previously been applied. The length of the tree channels decreased when the specimen was kept short-circuited for a longer period before the impulse voltage was applied.<sup>6)</sup> This is in a sense, a test method to verify the existence and evaluate the dissipation period of the space charge in polymers, but the specimen should breakdown electrically after the test.

In this paper, the mechanism of the EL observed when applying an impulse or an AC voltage will be discussed and its analysis will be shown to be useful for investigating the accumulation and dissipation of space charges in polymers without electrical breakdown.

## 1 Impulse Voltage

### 1-1 Experimental

Polyethylene terephthalate (PET) films (Lumirror, Toray Co. Ltd.) 12  $\mu\text{m}$  in thickness were used for the investigation. A semitransparent gold electrode was prepared by evaporating gold onto one surface of the specimen, and aluminum or gold onto the other. The specimen was mounted in a vacuum chamber with quartz windows evacuated to a pressure of  $< 10^{-3}$  Pa. Rectangular impulse voltages (pulse height  $\sim 700$  V, pulse width  $\sim 1$  ms) were used to excite the specimen. To investigate the space charge effect, a DC voltage ( $V_p$ ) was applied for a certain period ( $t_p$ ) prior to the application of the impulse voltage. A schematic diagram of the experimental apparatus is shown in Fig. 1. The mean brightness  $\bar{B}$  of the repeated light pulse emission was measured with a photomultiplier (R292, Hamamatsu TV) connected to a vibrating-reed electrometer (TR-84M, Takeda Riken). A single light pulse emission was measured with a synchroscope. The time constant of the measuring circuit was about 0.1 ms.

To eliminate spurious light emissions such as a discharge at a sharp edge of an electrode, the electrodes were prepared with decreasing thickness towards the edge and were covered with a mask so that the only light detected was that emitted from the

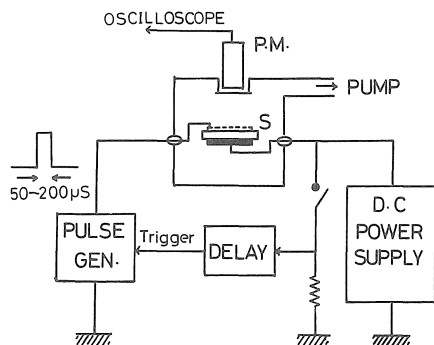

Fig. 1. Schematic diagram of experimental apparatus.

center of the electrodes.

### 1-2 Results and Discussion

In this paper, the brightness  $B$  is defined as the peak value of the photomultiplier output current observed with a synchroscope at a circuit time constant of about 0.1 ms, and the mean brightness  $\bar{B}$  is the average value of the photocurrents from the photomultiplier measured with a vibrating-reed electrometer.

The dependence of the mean brightness  $\bar{B}$  on the electrode is shown in Fig. 2, which was obtained by applying negative rectangular voltage pulses with a width of 50  $\mu\text{s}$  at 1 kHz to the rear Al or Au electrodes with the front Au electrode grounded. The difference between these curves is due to the difference in the material of the negatively-biased rear electrode. Since the work function of Al, 3.74 eV<sup>7)</sup> is lower than that of Au, 4.58 eV<sup>7)</sup>, it is reasonable to consider that electrons injected from the Al electrode are responsible for the difference between these two curves.

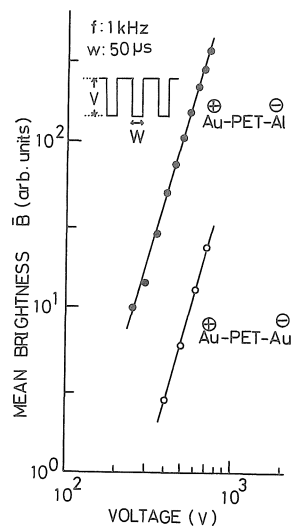

Fig. 2. Electrode dependence of EL brightness excited by repeated impulse voltage (50  $\mu\text{s}$  in width, 1 kHz).

Hartman *et al.*<sup>2)</sup> have reported the EL from polyethylene produced by applying AC voltages and have obtained the following empirical equation describing the brightness  $B$  as a function of the voltage  $V$ :

$$B \propto \exp[-211(V^{-1} - 1.3 \times 10^{-3} V^{1/2})]. \quad (1)$$

On the other hand, in the present case, the plot of  $\ln \bar{B}/F^2$  against  $F^{-1}$  gave a straight line with a negative slope as shown in Fig. 3.

If we assume the mean brightness  $\bar{B}$  to be proportional to the tunneling current through the interfacial barrier between PET and the electrode, the brightness  $\bar{B}$  is given<sup>8)</sup> by equation (2),

$$\bar{B} \propto F^2 \exp \left[ -\frac{8\pi(2m^*)^{1/2}\phi^{3/2}}{3heF} \right] \quad (2)$$

Where  $h$  is Planck's constant,  $m^*$  is the effective mass of the electron,  $\phi$  is the interfacial barrier height between the PET and the Al electrode and  $F$  is the electric field. By plotting  $\ln \bar{B}/F^2$  against  $F^{-1}$ ,  $m^*$  and  $\phi$  can be evaluated. The slope obtained from Fig. 3, however, was too small to give reasonable values for the effective mass  $m^*$  and the barrier height  $\phi$ . Assuming  $m^*$  to be  $1.0m$ ,  $0.1m$  or  $0.01m$ , the barrier height  $\phi$  was calculated from eq. (2) to be 0.05, 0.1 or 0.22 eV, respectively. The barrier height has been evaluated at 2.8 eV<sup>9)</sup> or 1.35 eV<sup>10)</sup> for the Al-PET interface. When the image force potential is taken into consideration, the barrier is reduced by an amount  $\Delta\phi$ , and then the tunneling equation given by eq. (2) is modified as follows:<sup>11)</sup>

$$\bar{B} \propto t^{-2}(\Delta\phi/\phi)F^2 \exp \left[ -\frac{8\pi(2m^*)^{1/2}\phi^{3/2}}{3heF} V(\Delta\phi/\phi) \right] \quad (3)$$

Where  $t(\Delta\phi/\phi)$  and  $V(\Delta\phi/\phi)$  are given numerically as a function of the field  $F$ .<sup>11,12)</sup> This modification,

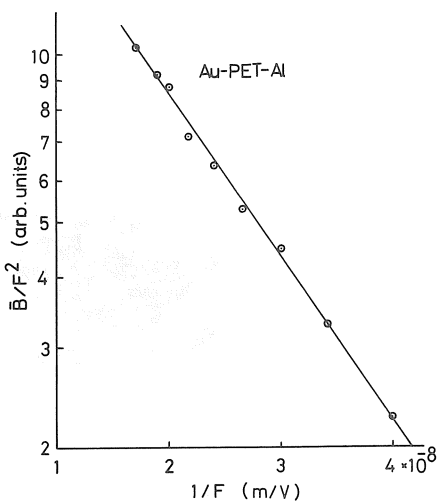

Fig. 3. Tunneling plot of mean brightness  $\bar{B}$ .

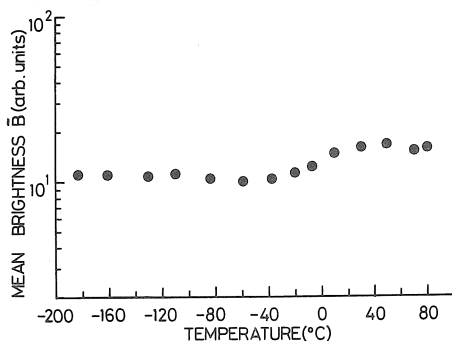

Fig. 4. Temperature dependence of mean brightness (700V, 100 $\mu$ s in width, 1 kHz).

however, still did not give a reasonable set of values of  $m^*$  and  $\phi$ .

Leaving aside this difficulty for the moment, let us consider the dependence of the EL on temperature. The EL intensity at 77 K was only 1.5~2 times lower than that at room temperature. The temperature dependence of the EL results from the various processes involved such as the carrier injection, the excitation of molecules and the light emission. In photoluminescence in PET excited at 300 nm, the fluorescence emission increased slightly as the temperature decreased. Its intensity at 77 K was twice that at room temperature. This suggests that the carrier injection and the excitation of molecules should be almost independent of temperature, or should increase slightly with temperature (Fig. 4). The excitation of molecules by high-energy electrons will not depend on temperature. Consequently, the injection process should be independent of temperature or have a very small activation energy. These facts support the tunneling injection of electrons, though there is still a quantitative difficulty in the validity of the estimated  $m^*$  and  $\phi$ .

The light emission from PET molecules might occur in two ways, i.e., a recombination of an electron with a hole injected or trapped in the PET, or radiational transition in molecules excited by impact with electrons accelerated by fields. It is more difficult to inject holes than to inject electrons.<sup>9)</sup> Bässler *et al.*<sup>13)</sup> have shown that covering the anode with an SiO<sub>2</sub> layer to block hole injection does not affect the emission. Furthermore, no trapped holes could be detected from the thermally-stimulated current analysis of the untreated PET film, while specimens previously subjected to a high negative field (1 MV/cm) from an Al electrode were found to have trapped electrons.<sup>14)</sup> Thus, the recombination of an electron and a hole injected from the electrodes cannot explain the results on the PET. Thus the electrons must be accelerated sufficiently to excite PET molecules or impurities if they exist.

Figure 5 shows a spectrum of the EL in PET at 77 K, compared with that of the photoluminescence excited at 300 nm. The detailed discussion on the photoluminescence in PET given in ref. 15 shows that the emission originate from the PET molecule itself. The photoluminescence at wavelengths shorter than 400 nm is the fluorescence emission and the remaining long-wavelength emissions are the phosphorescence emissions from the excited triplet state ( $\pi\pi^*$ ). Bässler *et al.*<sup>13)</sup> reported a similar spectrum of EL in PET and concluded the emission at wavelengths shorter than 450 nm to be due to the PET molecule and the longer part of the EL to be from impurities like naphthalene. This was founded on the fact that photoluminescence showed only fluorescence ( $\lambda < 450$  nm), while electroluminescence showed both fluorescence ( $\lambda < 450$  nm) and phosphorescence ( $\lambda > 450$  nm). Photoluminescen-

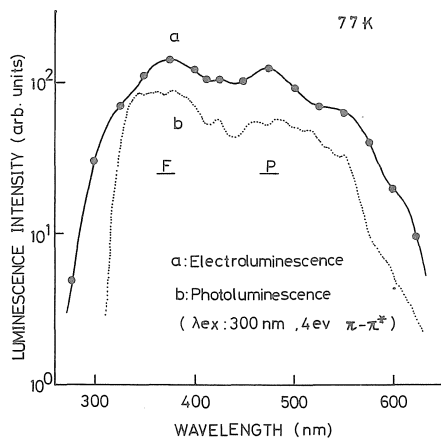

Fig. 5. Emission spectrum of EL and photoluminescence excited at 300 nm at 77 K.

ce, however, was found<sup>15)</sup> to show both fluorescence and phosphorescence when PET was excited at 300 nm at 77 K, as shown in Fig. 5. Both the fluorescence and the phosphorescence in photoluminescence and EL coincide fairly well with each other. Consequently it is not necessarily required to take impurities into account to explain the longer wavelength emission of EL. From this, it was concluded that the EL originates from excited PET molecules (terephthalate groups), and not from foreign impurities or other causes such as a partial discharge, which would give a different emission spectrum.<sup>3)</sup>

The injected electrons must gain energy from the field to excite the PET molecules at least into the lowest excited monomeric singlet state lying 4 eV above the ground state. The mean range of electrons in PET has been evaluated at about  $7 \times 10^{-10} \text{ cm}^2/\text{V}$  from the results of electron mobility measurement by the time of flight method.<sup>16)</sup> This is sufficient to accelerate electrons by a high field  $10^5 \sim 10^6 \text{ V/cm}$  to an energy of more than 4 eV within several hundreds of nm~several tens of nm. The lowest ionization potential of PET has not been reported yet, but ionization potentials of 6.7 eV<sup>17)</sup> and 6.9 eV<sup>18)</sup> were reported for the similar aromatic polymers, poly-

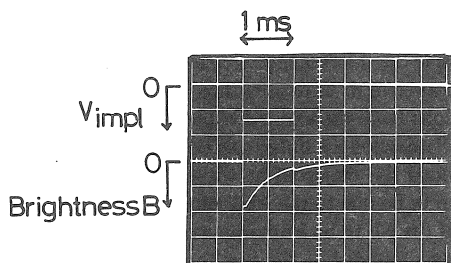

Fig. 6. Waveform of brightness excited by an impulse voltage (700 V, 1 ms in width, circuit time constant 450  $\mu\text{s}$ ).

styrene and poly-p-xylylene, respectively. Consequently it may also be possible to ionize PET molecules.

When the output current of the photomultiplier was observed with a synchroscope, it was found to decay even under the field shown in Fig. 6. This decay suggests the accumulation of injected electrons in the bulk or surface layer of PET as reported by Kaneto *et al.*<sup>4)</sup> The effect of the DC voltage applied previously on the specimen was discussed to evaluate the formation and the dissipation of the space charge. Figure 7 shows the photomultiplier output observed when an impulse voltage was applied to the specimen within one second after a DC voltage pre-applied for 10 minutes was removed. The emission was greatly enhanced when the impulse voltage had opposite polarity to that of the pre-applied voltage, while an impulse voltage with the same polarity resulted in emission nearly equal to or slightly less than that without the pre-application of the dc voltage. When a negative DC voltage was pre-applied to Au electrodes, there were no detectable changes in the emission by the impulse voltage in either polarity. This clearly shows the existence of the space charge due to the injected electrons, which causes the field enhancement when an impulse voltage with opposite polarity is applied. Hereafter we will discuss the EL observed when the specimen is short-circuited or subjected to an impulse voltage of opposite polarity to the pre-applied DC voltage.

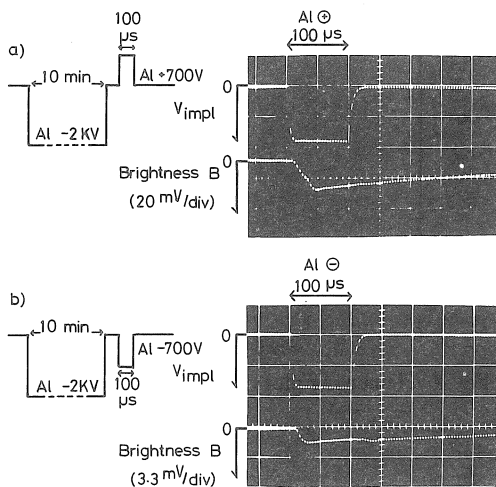

Fig. 7. Effects of pre-applied DC voltage on strength of EL by impulse voltages.

Figure 8 shows the brightness  $B$  as a function of the DC voltage  $V_p$  pre-applied to the specimen for 10 minutes with the rest time  $t_r$  as a parameter. The light emission was also observed on short-circuiting the electrodes. Although, strictly speaking, the decay time of the pre-applied voltage on short circuiting was about 0.1 ms, it is denoted as the short-circuit emission for convenience. The relation  $B \propto V_p^{3.3}$  was

identical with that observed in Fig. 2. This suggests that the light emission mechanism is identical for both the impulse voltage EL and short-circuit emission, while the former results from the applied external field and the latter results from the internal space charge field. In the case of short-circuit emission, electrons are ejected from traps by the internal field on short-circuiting. These electrons are accelerated to excite PET molecules. If the PET molecules are ionized by the pre-applied high field, another process may be possible, i.e., the field-enhanced recombination luminescence<sup>19)</sup> which has been observed in the isothermal luminescence (after-glow) from polymers irradiated with high-energy radiation. When PET is excited at low temperatures by an electron beam or photons, thermoluminescence having a similar spectrum to that of photoluminescence can be detected.<sup>20,21)</sup> This suggests that PET molecules are ionized and trapped electrons and positive molecular ions are generated. On the other hand, when a DC voltage ( $\sim 1.8$  MV/cm) was applied at 77 K or room temperature, no thermoluminescence was detected with the same photodetecting system as that used in the above experiment. This suggests that the ionization of PET molecules is not likely to occur by collision with high-energy electrons.

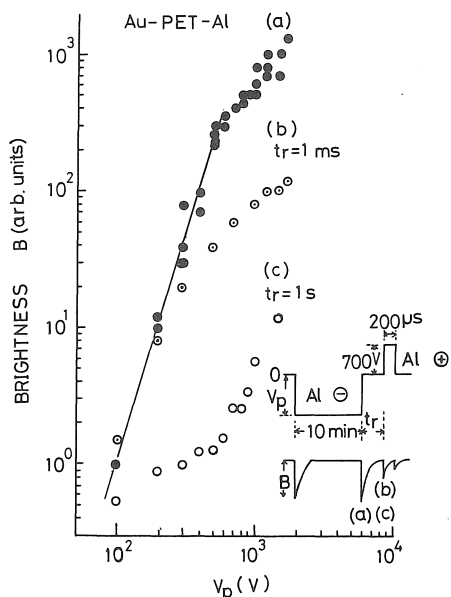

Fig. 8. Dependence of brightness  $B$  on pre-applied DC voltage with rest time  $t_r$  as parameter. (a): short-circuit emission, (b): impulse voltage EL,  $t_r = 1$  ms, (c): impulse voltage EL,  $t_r = 1$  s.

The decay of the space charge after short-circuiting during a certain period  $t_r$  can be evaluated by applying an impulse voltage of opposite polarity to the pre-applied DC voltage to enhance the internal field. The results shown in Fig. 8 suggest that the

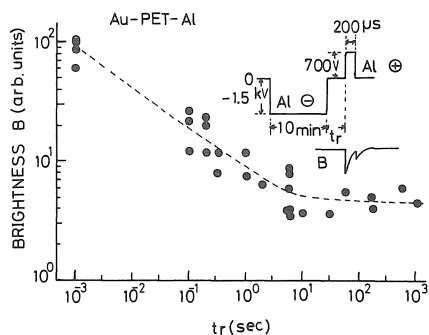

Fig. 9. Dissipation characteristics of space charge injected from Al cathode by pre-applied DC voltage (at room temperature).

decay rate of the space charge increases at higher pre-applied voltages.

The dissipation of the space charge is shown more directly in Fig. 9. A DC voltage of 1.5 kV was applied for 10 minutes to a specimen with an Al cathode. When the rest time was shorter than about 1 s, the brightness  $B$  decayed rapidly while it slowly decreased over 1 s and was still larger than the brightness without pre-application of the DC voltage. Space charge, especially hetero-space charge, has been found to reduce treeing breakdown voltages.<sup>5,6)</sup> The extinction period of the space charge effect on the tree initiation voltage or the tree length was of the order  $10^3$  s when the DC voltage was pre-applied for a long period ( $10^2 \sim 10^3$  s).<sup>5,6)</sup> The present results are consistent with these results.

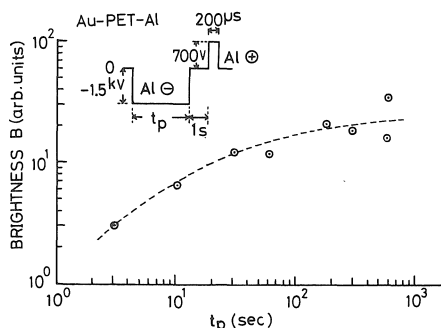

Fig. 10. Accumulation of space charge injected from Al cathode by pre-applied DC voltage (at room temperature).

Finally, the accumulation of the space charge was evaluated by discussing the brightness  $B$  as a function of the period of pre-application of the DC voltage as shown in Fig. 10. The brightness  $B$  tends to saturate at about  $10^2$  s, suggesting that the space charge of injected electrons takes  $10^2$  s to reach its steady state at room temperature. Another short-time accumulation of space charge has been suggested from Fig. 6. These are not inconsistent because short and long time decays of the space charge have been observed

as shown in Fig. 9 and they are related to shallow and deep traps, respectively.

## 2 AC Voltage

### 2-1 Experimental

Specimens were commercially-available PET films (Lumirror, Toray Co., Ltd.). A semitransparent Au electrode was prepared by evaporation in vacuum ( $\approx 10^{-3}$ Pa) on one side of the specimen, while an Au or Al electrode was formed on the other side. Sinusoidal AC voltages (60 Hz) were applied to the specimen with the rear Au or Al electrode grounded as shown in Fig. 11. All measurements were carried out in a vacuum of about  $10^{-4}$ Pa. The mean brightness  $\bar{B}$  of the EL was measured by a photomultiplier (HTV, R432) connected to a vibrating-reed electrometer (TR84M, Takeda Riken), and the waveform of light pulses was recorded by an oscilloscope with a circuit time constant of 0.1 ms.

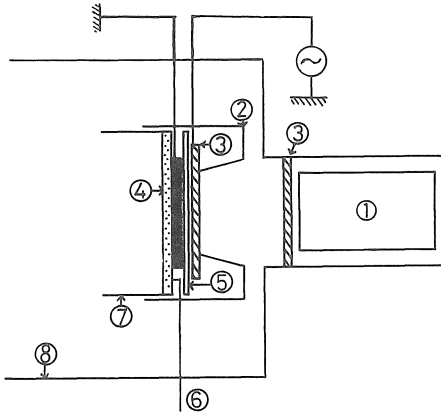
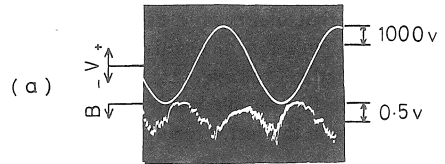

Fig. 11. Electrode arrangement for measuring EL under an AC voltage. 1 photomultiplier 2 screen 3 quartz 4 boron nitride 5 specimen 6 thermocouple 7 temperature-controlled sample holder 8 vacuum vessel.

### 2-2 Results and discussion

The waveform of the EL from PET films under an AC voltage is shown in Fig. 12. The waveform of the EL in the symmetrical electrode arrangement (Au-PET-Au) was symmetrical in each half-cycle of AC voltages. On the other hand, they were asymmetrical when the electrode arrangement was asymmetrical (Au-PET-Al). The EL intensity was higher when the Al electrode was at the positive half-cycle of the AC voltage. This asymmetrical property of the EL shows clearly that the EL observed here is the result of carrier injection from the electrode and not of other spurious effects such as corona discharge.

Electroluminescence generally results from double injection or single injection of carriers from the electrodes. In the former case, holes and electrons



(a) V o—Au-PET-Au— $\text{A}$   
V:1000 v/div  
B:0.5 v/div

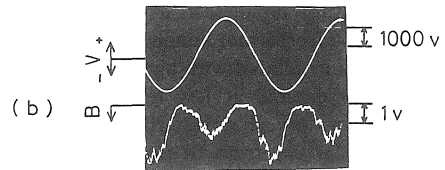

(b) V o—Au-PET-Al— $\text{A}$   
V:1000v/div  
B:1v/div

Fig. 12. Oscillograms of EL under sinusoidal AC voltages (60 Hz, 1800 V<sub>peak</sub>), a) Au-PET-Au, b) Au-PET-Al.

recombine with each other and emit light. On the other hand, in the latter case, electrons or holes injected from the cathode or the anode respectively are accelerated by the electric field and gain sufficient energy to excite or ionize molecules. Light is emitted when the excited or ionized molecules return to the ground state. Shimizu *et al.*<sup>3)</sup> have proposed a recombination model for the EL under an AC voltage in polyethylene and explained their experimental result that the waveform of light emission was asymmetrical. In their model, holes injected during positive half-cycles of the AC voltage are deeply trapped and recombine with electrons injected during the following negative half-cycle. We, however, have obtained<sup>14)</sup> the experimental result that electrons are easily injected into PET from the Al electrode but holes are not, even from an Au electrode with a higher work function. This suggests that single injection prevailed in the present experiment.

We must therefore explain the fact that the EL intensity is higher during the positive half-cycle with the Al electrode but not during the negative one. This can be explained by considering the accumulation of the electron space charge near the Al electrode. The existence of a space charge of injected electrons has been suggested previously in the case of EL under rectangular pulse voltages.<sup>22)</sup> However it is probably dangerous to conclude that the space charge also remains under the AC voltage, because the alternating field may dissipate it. Consequently, we carried out TSC analysis to check whether space charge accumulates under an AC voltage. Figure 13 shows

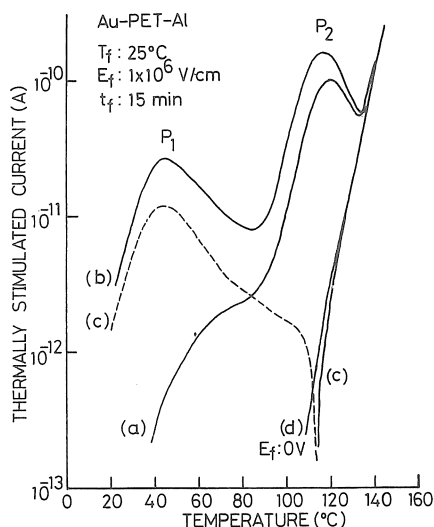

Fig. 13. TSC spectra of PET electret (Au-PET-Al) formed under (a): AC field, (b): half-wave rectified sinusoidal AC fields (Au<sup>+</sup>-PET-Al<sup>-</sup>) and (c): Au<sup>-</sup>-PET-Al<sup>+</sup>. Curve (d) is the TSC in a virgin sample with no previous application of field.

TSC spectra obtained from PET electrets formed under two kinds of excitation, i.e., sinusoidal and half-wave rectified sinusoidal AC voltages. The AC voltage was reduced to zero gradually, since injected charges may remain in the sample if the AC voltage is suddenly removed. The peak P<sub>2</sub> was observed when the Al electrode was negatively biased under continuous sinusoidal or half-wave rectified sinusoidal AC voltages. This clearly shows that the electrons are injected from the Al electrode and remain near the Al electrode as a space charge and that the space charge hardly dissipates at all during each period of the AC voltage (1/60 s). On the other hand, peak P<sub>1</sub> resulted from the release of trapped electrons and the dipolar relaxation occurring at the same time at these temperatures.<sup>14)</sup> The EL intensity under excitation of both rectangular voltage pulses and AC voltages decreased gradually, as shown in Fig. 14. This also suggests that space charge accumulates significantly under DC voltage pulses and that it also grows under AC voltages.

In conclusion, the single injection of electrons from the electrodes and the succeeding accumulation of space charge is the most suitable model to explain the present results. My final qualitative model is as follows. Electrons injected from the electrodes (especially Al electrodes) during the negative half-cycle of the AC voltage are trapped and form a space-charge layer. The space charge partly dissipates as the voltage decreases to zero but the major part of it remains trapped near injecting electrode (Al). The electric field at the PET-injecting (Al) electrode

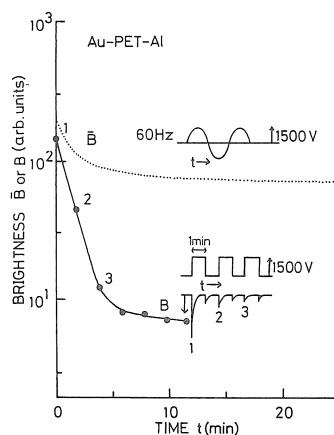

Fig. 14. Brightness of EL as a function of time.  $\bar{B}$  and  $B$  are the mean brightness and the peak brightness, respectively.

interface is enhanced during the next positive half-cycle. Electrons are then detrapped and accelerated by the enhanced field to excite PET molecules into their excited states. Thus the EL is enhanced during the positive half-cycle of the injecting electrode (Al) as shown in Fig. 15. The spectrum and voltage dependence of the EL under an AC voltage was similar to that under rectangular voltage pulses,<sup>22)</sup> the latter being explained as a result of the tunneling injection of electrons from the electrodes.

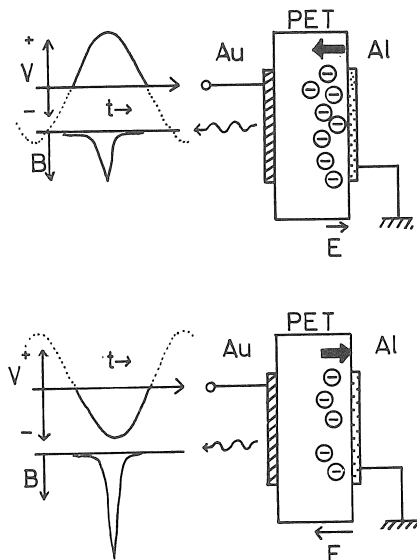

Fig. 15. Schematic diagram of the model.

### 3 Summary

The carrier injection processes and behaviors of space charges were investigated by the electroluminescence (EL) measurements. The EL in PET was concluded to occur when the excited or ionized PET molecules by collision of injected electrons, were

deactivated into their ground state. It was suggested that the tunnelling emission at the Al-PET contact was concerned to the carrier injection process. The lifetime of trapped electrons in PET at room temperature were estimated at the order of 1 sec and  $10^3$  sec, corresponding to the shallow and deep traps.

Furthermore, it is noticeable that carrier injection and accumulation occur under an AC field, especially in the specimen with the asymmetrical electrode system (Au-PET-Al).

#### Acknowledgments

The author wish to thanks prof. M. Ieda and Drs. T. Mizutani and Y. Takai of Nagoya Univ. and prof. G. Sawa of Mie Univ. for their helpful discussions. This work was supported in part by a Grant-in-aid for Scientific Reserch from the Ministry of Education, Science and Culture.

#### References

- 1) H. C. Longuet-Higgins, L. Salem: Proc. Soc. London Ser A, **251**, (1959) 172
- 2) H. A. Hartman and H. L. Armstrong: J. Appl. Phys. **38** (1967) 2392.
- 3) N. Shimizu, H. Katsukawa, M. Miyauchi, M. Kosaki and K. Horii: IEEE Trans. Electr. Insul. EI **14** (1979) 256.
- 4) K. Kaneto, K. Yoshino, K. C. Kao and Y. Inuishi: Jpn. J. Appl. Phys. **13** (1974) 1023.
- 5) M. Ieda and M. Nawata: IEEE Trans. Electr. Insul. EI **12** (1977) 19.
- 6) N. Yoshimura, H. Sato, M. Nishida and H. Noto: Trans. Inst. Electr. Eng. Jpn. **98-A** (1978) 223 [in Japanese].
- 7) H. B. Michaelson: J. Appl. Phys. **21** (1950) 536.
- 8) D. R. Lamb: *Electrical Conduction Mechanisms in Thin Insulating Films* (Methuen and Co., London, 1967) p.56.
- 9) T. Mizutani, Y. Takai, T. Osawa and M. Ieda: J. Phys. D **9** (1976) 2253.
- 10) D. M. Taylor and T. J. Lewis: J. Phys. D **4** (1971) 1346.
- 11) J. J. O'Dwyer: *The Theory of Electrical Conduction and Breakdown in Solid Dielectrics* (Clarendon Press, Oxford, 1973) p.82.
- 12) R. H. Good and W. Müller: *Handbuch der Physik Field Emission* (Springer Verlag, Berlin, 1956) Vol. 21, p. 176.
- 13) H. Bässler, G. Vaubel, K. Rasskopf and K. Reinke: Z. Naturforsch. **26** (1971) 814.
- 14) K. Kojima, A. Maeda, Y. Takai and M. Ieda: Jpn. J. Appl. Phys. **17** (1978) 1735.
- 15) Y. Takai, T. Mizutani and M. Ieda: Jpn. J. Appl. Phys. **17** (1978) 651.
- 16) K. Hayashi, K. Yoshino and Y. Inuishi: Jpn. J. Appl. Phys. **14** (1975) 39.
- 17) C. B. Duke, W. R. Salaneck, T. J. Fabish, J. J. Ritsko, H. R. Thomas and A. Paton: Phys. Rev. **B 18** (1978) 5717.
- 18) Y. Takai and M. Ieda: *Developments in Polymer Photochemistry-3*, N. S. Allen ed., (Applied Science Publishers LTD) (1982), 93.
- 19) A. E. Blake and K. J. Randle: J. Phys. D **10** (1977) 759.
- 20) K. Kojima, Y. Takai and M. Ieda: Trans. Eng. Jpn. **100-A** (1980) 535 [in Japanese].
- 21) Y. Takai, K. Mori, T. Mizutani and M. Ieda: J. Polym. Sci. **16** (1978) 1861.
- 22) K. Kojima, Y. Takai and M. Ieda: Jpn. J. Appl. Phys. **21** (1982) 860.

(Received January 17 1984)